

KOBAN



FEATURES

- ✓ IP55, IK10
- ✓ with fast connector
- ✓ Simple and integrative structure design, easy in installation.
- ✓ Housing with high heating PC material, excellent heating radiation performance.
- ✓ High luminous efficacy, small lumen depreciation, long lifespan



TECHNICAL SPECIFICATIONS

	KLED-CE9001-15W 8768099	KLED-CE9001-15W-HF 8768132
LED light source	SMD2835	SMD2835
Input voltage	180-240V AC	180-240V AC
Lm/W	>70	>70
Lumen	1100±10%	1100±10%
Power	15W	15W
CRI	Ra>80	Ra>80
Color temp.	3000K/4000K/6500K	3000K/4000K/6500K
Lifetime	50000hr	50000hr
Total harmonic distortion	<10%	<10%
Work humidity	20-80%RH	20-80%RH
IP Rating	IP55	IP55
IK Rating	IK10	IK10
Glow wire	850°C	850°C
Class	Class II	Class II
Microwave sensor	No	Yes

	KLED-CE9001-15W 8768099	KLED-CE9001-15W-HF 8768132
Power factor	>0.9	>0.9
Beam angle	120°	120°
Material	PC base + PC cover	PC base + PC cover
Anti-uv	Yes	Yes
Size(mm)	Φ270*93mm	Φ270*93mm

DIMENSIONS

KLED-CE9001-15W

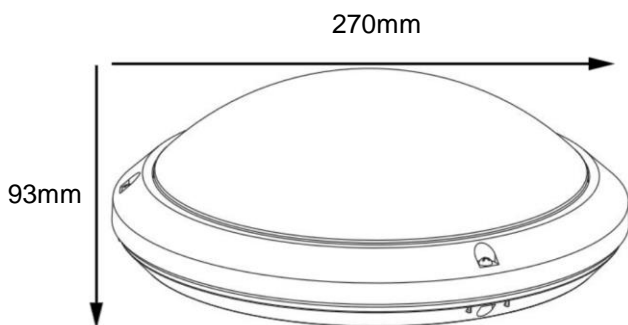

KLED-CE9001-15W-HF

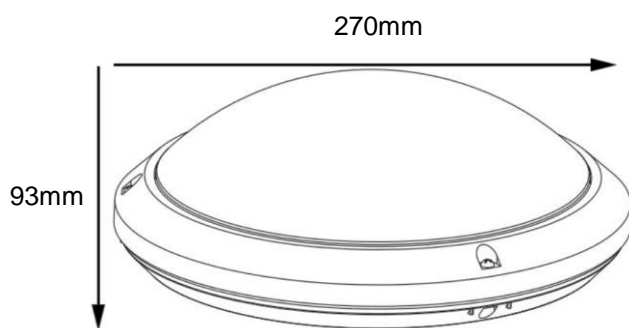

GAMMA ANGLE

KLED-CE9001-15W

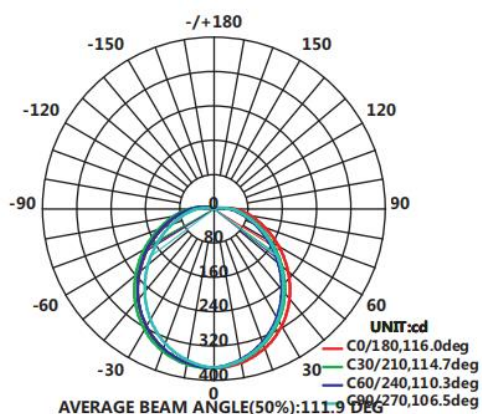

KLED-CE9001-15W-HF

